



FIRST TUNNELS

the growing season just got longer



www.FirstTunnels.co.uk/Quality

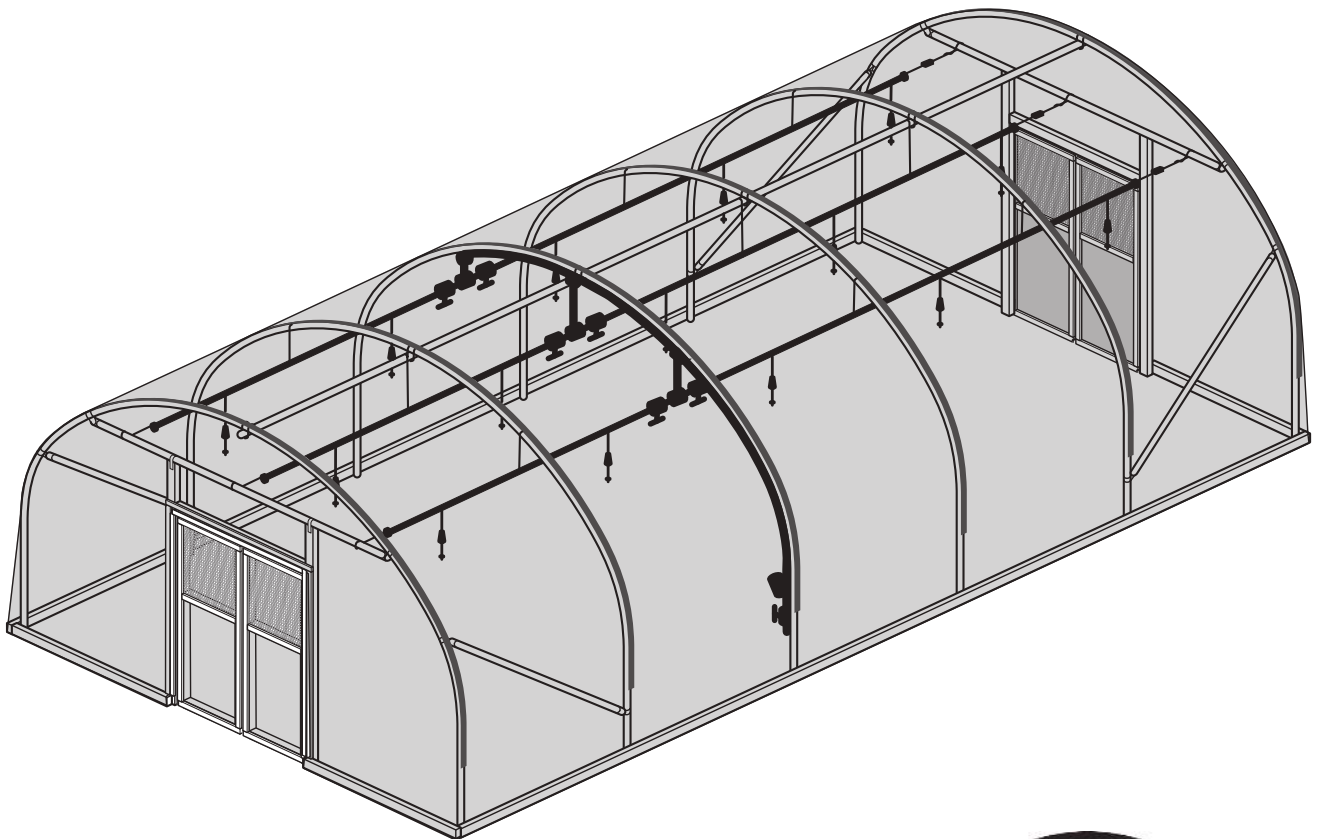

Overhead Triple Line Irrigation Installation Guide

COM 3



Warnings



General

- Please keep children and pets away from the work area.
- If any holes are not to be filled for a period of time, please cover them over.
- Keep the working area free of tools and parts.
- Always wear safety glasses, ear defenders and a face mask where applicable.
- Wear gloves when working with the metal parts.
- Never wear loose clothing, hanging hair or jewellery.
- Always use sharp tools.
- Never carry any sharp tools in your pocket.
- Never use yourself or anyone else for support.
- Heavy items – Don't try lifting a heavy item by yourself, get some help.

Wire

- Care must be taken when unrolling, cutting and using the wire. Always use safety goggles.

Ladders

- Never overreach when working on a ladder or steps.
- Reposition a ladder to avoid the risk of overbalancing.
- Make sure you are well balanced for the start and the finish of an operation.
- Always use stabilizers, tie or get somebody to stand on the bottom of ladders.
- Use the ladder rule - one measure out for every four measures in height.
- Ladders should be placed on a firm level surface.
- The top should rest on something solid.

Electrical power tools

- Always use RCD's (Residual Current Devices) when using power tools outdoors.
- Never use in wet conditions.
- Follow the safety instructions provided with the tools.

Overhead Irrigation Installation Guide

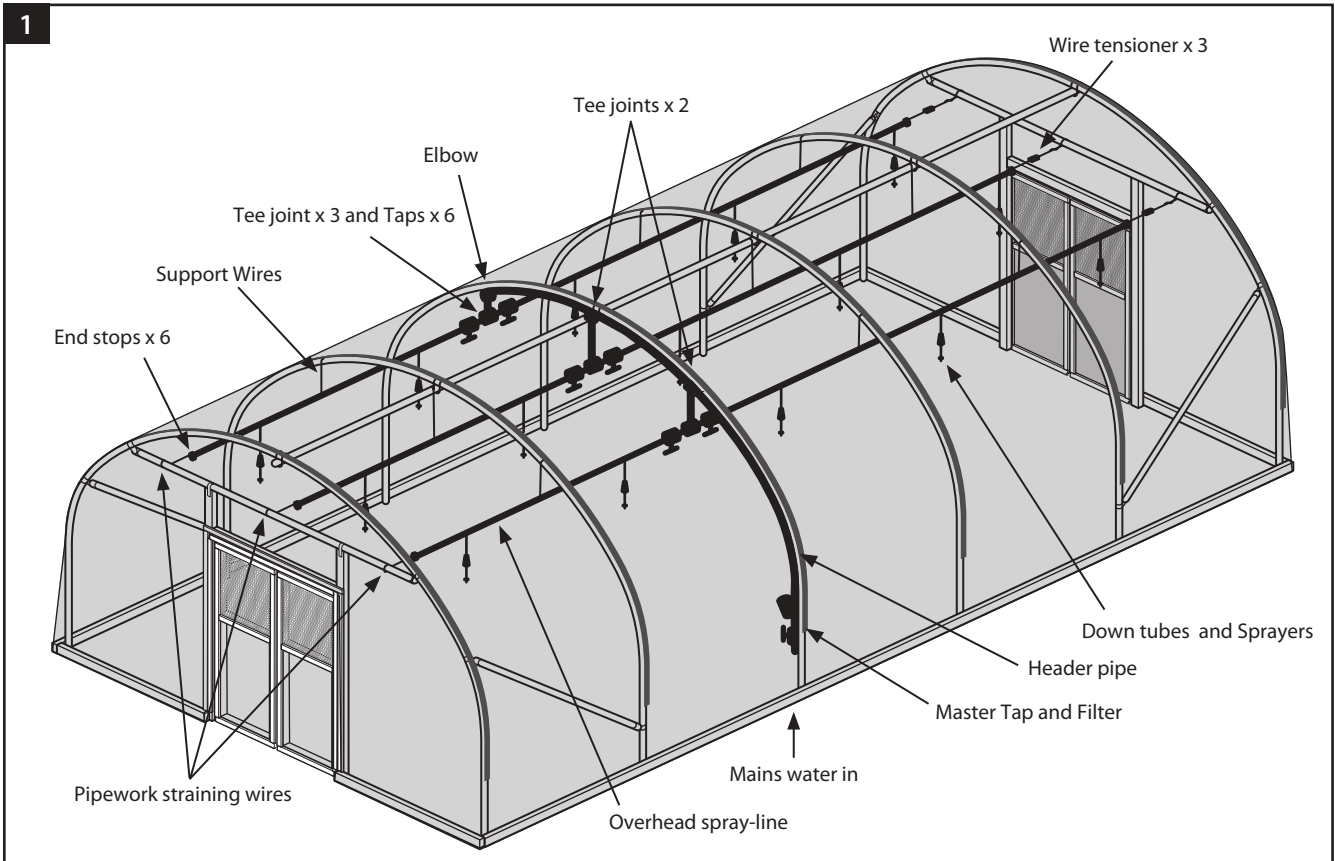

Overhead Irrigation

This system involves the water supply entering at one side of the polytunnel on an intermediate hoop (preferably the centre hoop, but can be any intermediate hoop). The supply is then distributed down 6 lines each

independently controlled through a manual ball valve. If the water supply cannot accommodate all 6 lines at once, then up to 5 lines can be isolated to increase supply to the other one. This has the added advantage of only watering areas of the polytunnel in use (**dia. 1**).



WARNING:

Warning when unrolling, cutting and handling the wire always use safety goggles

TOOLS REQUIRED. Hacksaw, Pliers, Wire cutters and a Small adjustable spanner.

Overhead Spray-line

To support the system, three straining wires are run down the length of the polytunnel, these should be placed to divide the polytunnel equally into four. The end of each wire should be taken around the metal door rail (**dia. 2**) or a hole can be drilled (use a 4-6mm bit) through the door post at a minimum of 23cm above the top of the door opening (**dia. 3**).

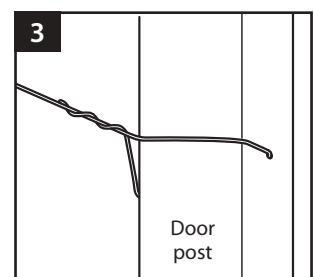
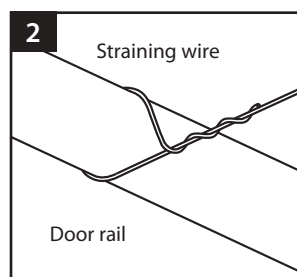

Overhead Irrigation Installation Guide

At the other end of the polytunnel a short piece of wire (approximately 30-45cm) should be positioned similarly, with a wire tensioner on the free end. Feed the first straining wire through the tensioner and tension until the wire is straight (**dia. 4**).

To support the wire at the point where it passes below an intermediate hoop, cut a length of wire 30cm longer than the gap between the underside of the hoop and the straining wire (**dia. 5 detail**). Bend this wire at one end into a small loop and, using a cable tie through the loop, fix this wire to the hoop, bend the other end around the full length straining wire ensuring that the wire is at a level position (**dia. 5**).

Overhead Pipework

Cut three lengths of 25mm pipe the length of your polytunnel and place a male plug in each end. To fit the male plug slide the coupling nut onto the pipe (tapered end first) push the grip ring (red) into the end of the pipe, These barbed fittings are a tight fit and may require some force to fully press home.

TIP

Inserting the plug fittings (red) into the pipe can be very tight - holding the pipe in hot water for a few seconds will help.

Push the male plug onto the grip ring/pipe and screw on the coupling nut and hand tighten (**dia. 6**).

Suspend these three pipes from the straining wire using the plastic support hooks placed every 60cm (**dia. 7**).

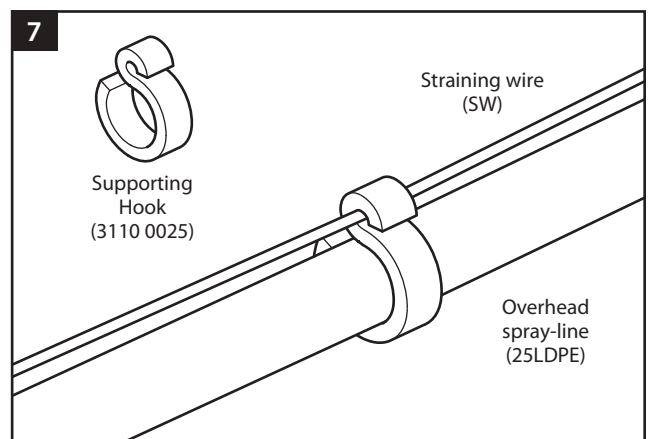
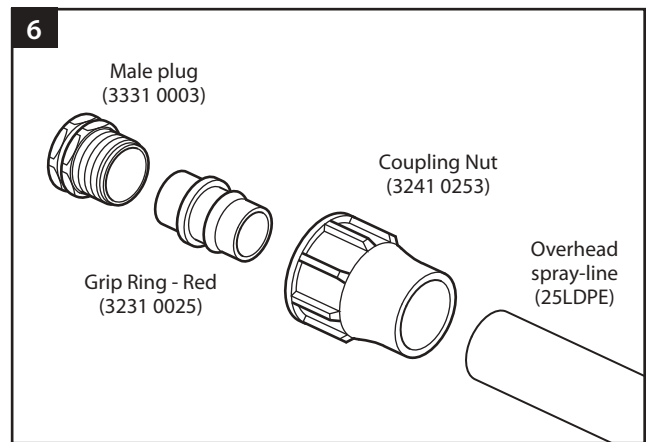
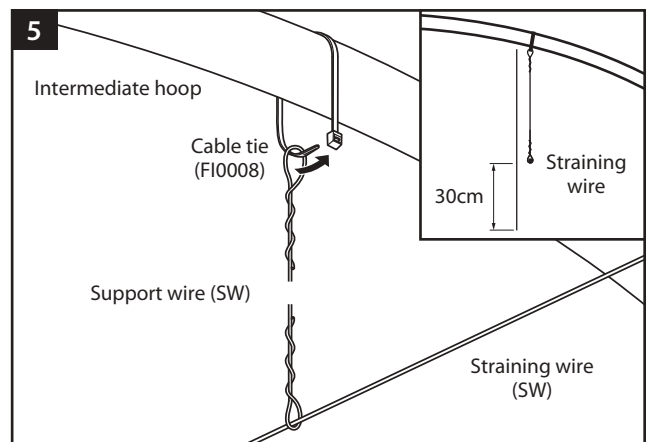
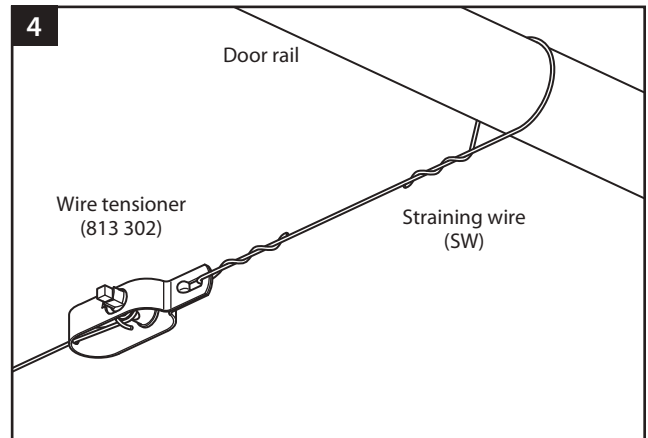

Overhead Irrigation Installation Guide

Choose the intermediate hoop where your water supply will enter (**dia. 8**).

At the point directly under the hoop remove 30cm piece (15cm either side of the hoop centre) of the 25mm pipe (in effect you should split the three lengths of pipe into six). Assemble the three distribution tees and ball valves, using the PTFE tape on the joints between the two (**dia. 9**). Now use this assembly to join the pipes back together using the grip rings (red) and coupling nuts as described above.

Water inlet system

Assemble the inlet system, making sure the water flow follows the direction arrows stamped on the filter. PTFE tape should be placed around the thread end of the filter (**dia. 10 and 10 detail**).

Fix an elbow to the end of the remaining 25mm pipe using the grip rings (red) and coupling nuts. Using the cable ties supplied strap this pipe to the underside of the intermediate hoop, approx. every 50cm with the elbow directly over the spray line furthest away from the water inlet (**dia. 11**).

TIP

Flush out and drain water irrigation tubes so they don't crack in frosty weather

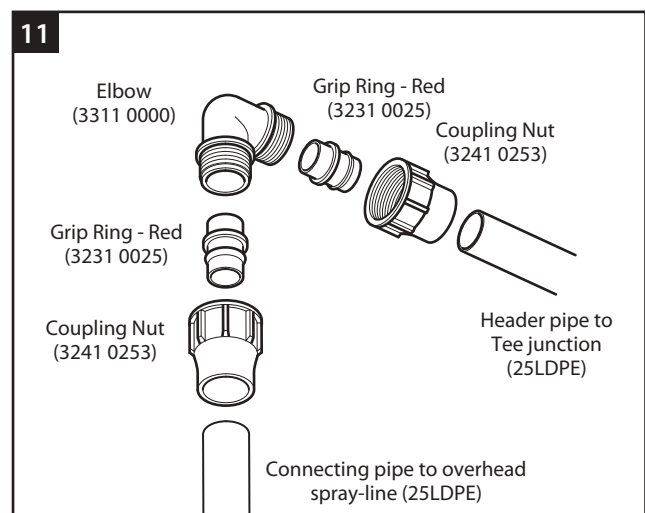
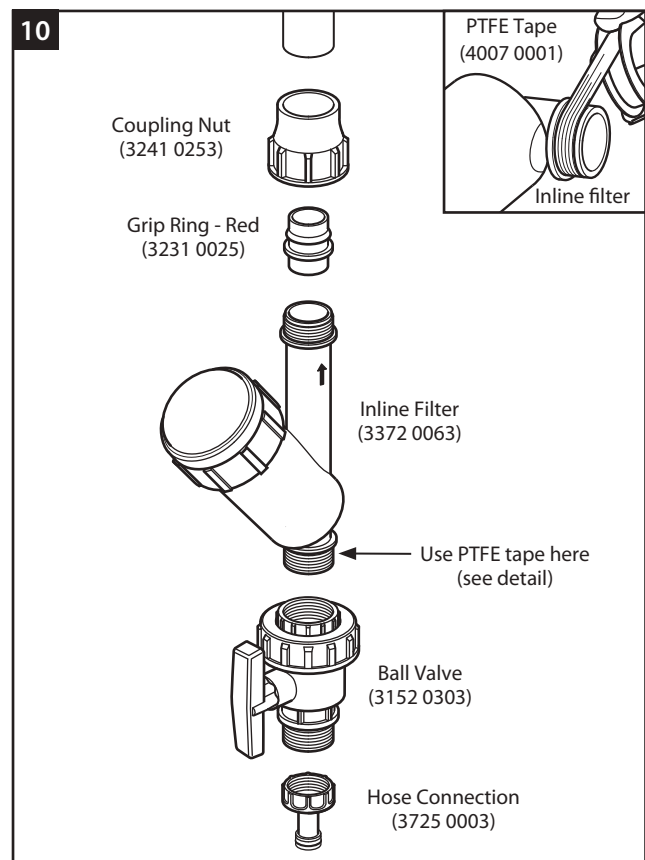
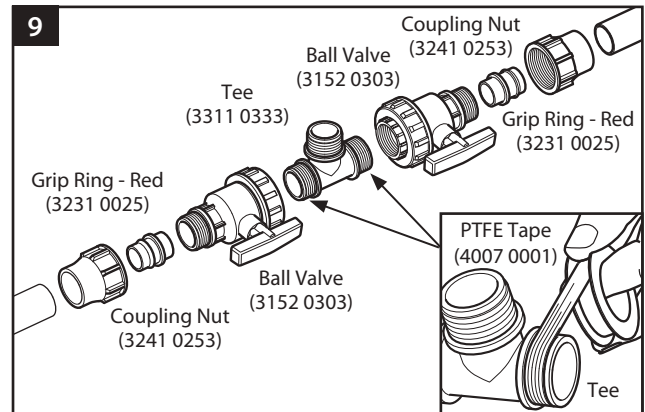
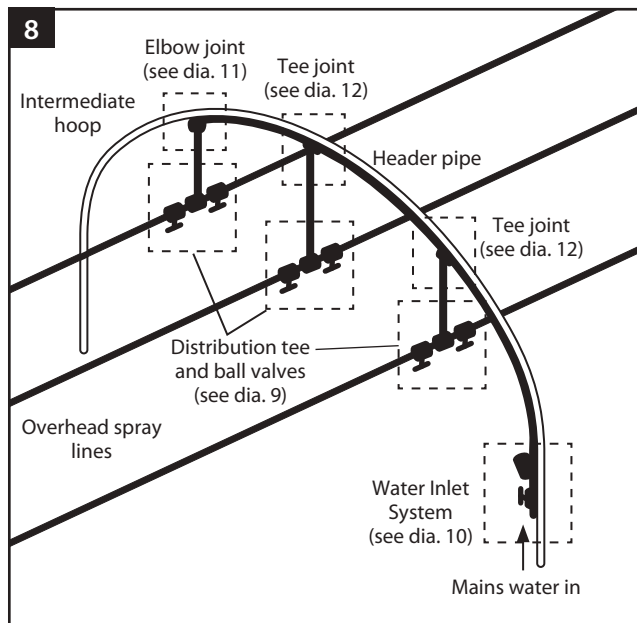

Overhead Irrigation Installation Guide

Cut the pipe where it goes over the next spray line (middle) and fit a tee (**dia. 12**).

The pipework should then run along the underside of the hoop until it goes over the next line (nearest the water inlet) where it should be cut and another tee fitted. Fit the pipe along the underside of the hoop and fix it to the filter and Ball Valve using an insert and coupling nut.

Water connecting pipes

Cut two pieces of the remaining pipe and join each of the spray lines to the header pipe to complete the system.

Spray Nozzles

Punch a hole in the underside of the spray line centrally between each hoop (**dia. 13 detail**).

Insert a down tube adaptor in each hole using the punch for assistance.

Assemble the down tube and spray nozzle (**dia. 13**) and insert into each of the adaptors. Note the direction of flow on the Anti drip valve.

TIP

The Anti Drip Valve used is designed to prevent the sprayers from dripping when the water supply is turned off. However, low water pressure supplies may not close the valve and so prevent the system from working correctly. If so these valves can be removed to improve the effectiveness of the system.

Prestige Overhead Irrigation (if ordered).

If you ordered a Prestige Irrigation System then you will need to fit the Water Controller onto the tap of your water source. The water controller is supplied with fittings for either a 3/4in or 1in male threaded tap. Use the two 'Hose to Female Click' fittings to run a hose between the 'Male Click' fittings on the Water Controller and the Polytunnel. You will require a hose pipe and may require extra 'Click' fittings depending on the type of tap being used.

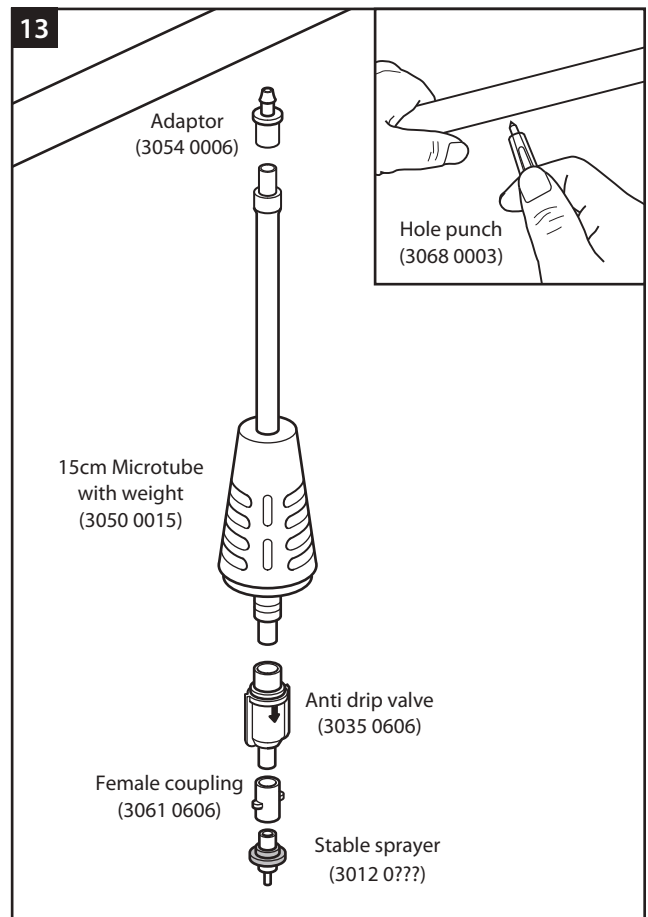
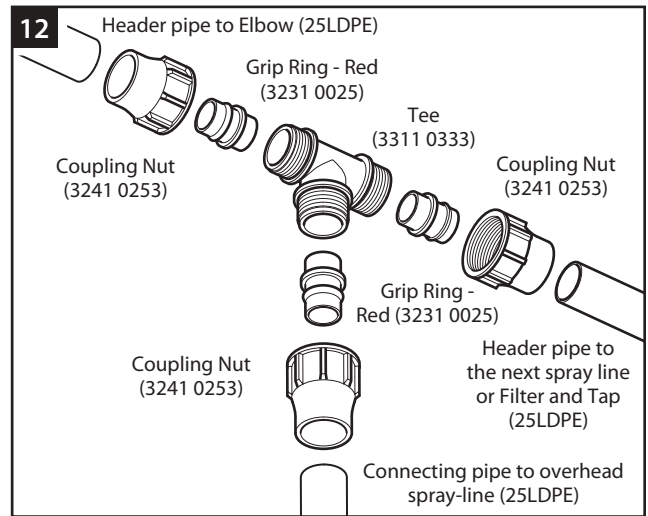

PARTS

Quantities depend on the length of your Polytunnel

CIF, CIFEX



Male plug
(3331 0003)



Elbow
(3311 0000)



Tee
(3311 0333)

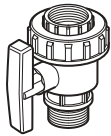

Ball Valve
(3152 0303)

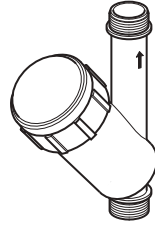

Inline Filter
(3372 0063)



Hose Connection
(3725 0003)



Coupling Nut
(3241 0253)



Grip Ring - Red
(3231 0025)

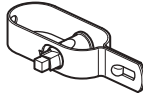

Wire Strainer
(813 302)

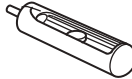

Hole punch
(3068 0003)



PTFE tape
(4007 0001)

Commercial Irrigation Fittings

DTA

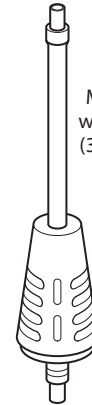

15cm
Microtube
with weight
(3050 0015)



Adaptor
(3054 0006)



Anti drip
valve
(3035 0606)



Female
coupling
(3061 0606)



Stable
sprayer
(3012 0???)

Down Tube Assembly

SW

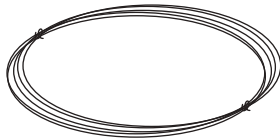

Straining Wire

25LDPE

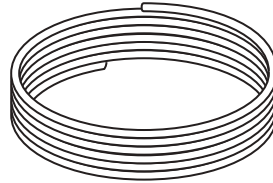

LDPE 25mm Pipe (6bar)

FI0008

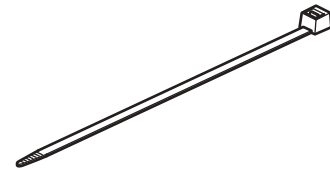

27cm Cable Ties

3110 0025



Supporting Hook

WC0001, 3711 0001

Hose connection
(3711 0001)

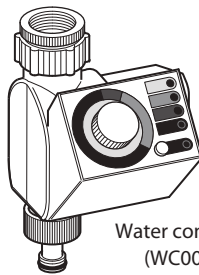

Water controller
(WC0001)

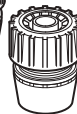
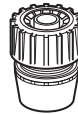

Controller and Connectors



FIRST TUNNELS

the growing season just got longer

If you experience any difficulties during construction please call us on:

Monday to Friday (9am - 5pm) 01282 601253
Saturday & Sunday (9am - 5pm) 07801 601253
Email/Web: help@firsttunnels.co.uk or visit our web site www.polytunnels.co.uk for assistance.



We know many people build their polytunnels at the weekend when our office is closed.

So we've set up the First Tunnels Construction Helpline specifically for these weekend periods. This allows you to talk directly to a constructor, ask their expert opinion, get the answers and complete your polytunnel.

If you'd like us to ring you, simply send us a text and we'll ring you back. If you are an O2 customer the call will be free of charge. Please note this service is NOT available over the Christmas period and Bank Holidays.

Share your gardening pictures and videos, post hints, tips and experiences.
PLUS... find out more about our online gardening community.



www.PolytunnelGardening.co.uk



www.facebook.com/polytunnels



www.youtube.com/polytunnels

Copyright © First Tunnels Ltd 2012.

All rights reserved. No part of this document may be reproduced or transmitted in any form, by any means (electronic, photocopying, storing in any medium, recording, or otherwise) without the prior written permission of First Tunnels Ltd.