



# FIRST TUNNELS

*the growing season just got longer*



[www.FirstTunnels.co.uk/Quality](http://www.FirstTunnels.co.uk/Quality)

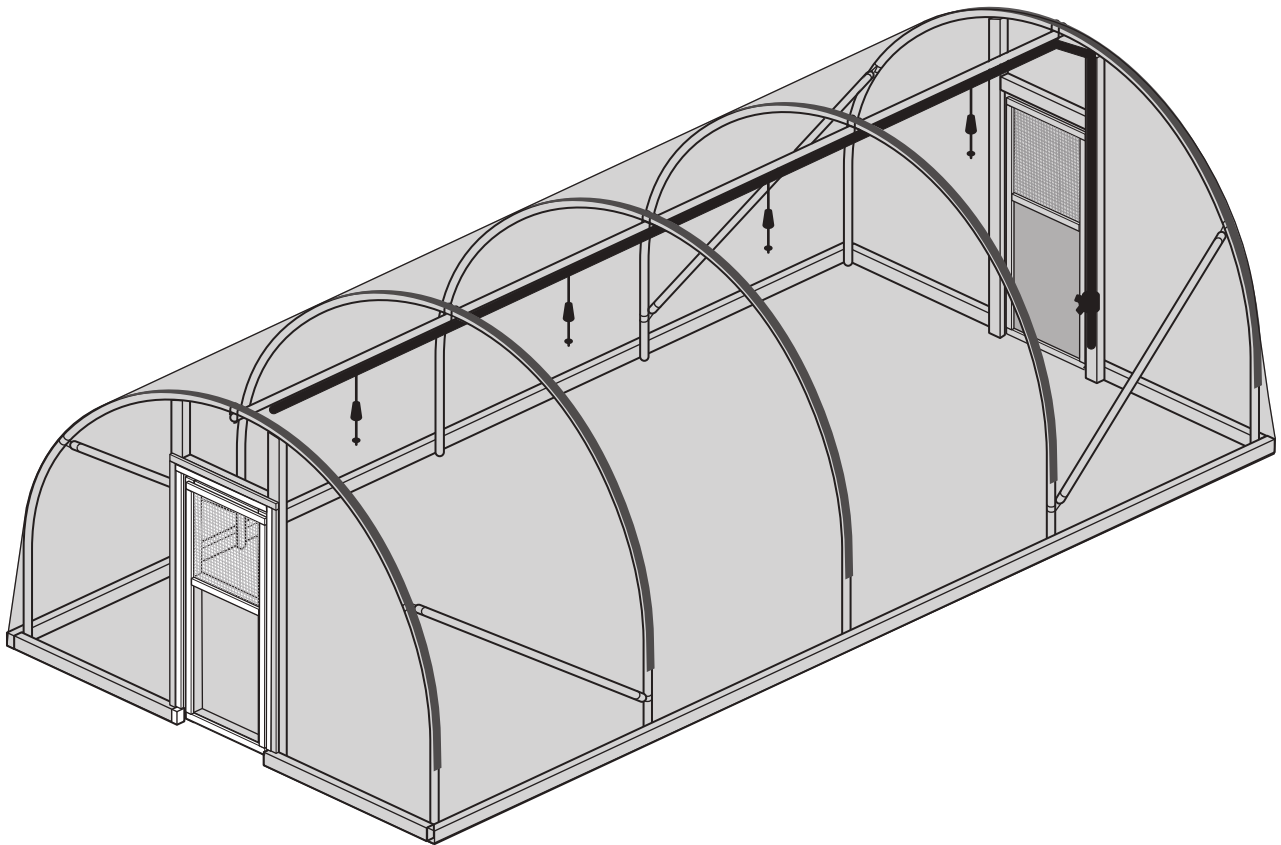

## Overhead Irrigation Installation Guide

**DOM**



# Warnings



## General

- Please keep children and pets away from the work area.
- If any holes are not to be filled for a period of time, please cover them over.
- Keep the working area free of tools and parts.
- Always wear safety glasses, ear defenders and a face mask where applicable.
- Wear gloves when working with the metal parts.
- Never wear loose clothing, hanging hair or jewellery.
- Always use sharp tools.
- Never carry any sharp tools in your pocket.
- Never use yourself or anyone else for support.
- Heavy items – Don't try lifting a heavy item by yourself, get some help.

## Ladders

- Never overreach when working on a ladder or steps.
- Reposition a ladder to avoid the risk of overbalancing.
- Make sure you are well balanced for the start and the finish of an operation.
- Always use stabilizers, tie or get somebody to stand on the bottom of ladders.
- Use the ladder rule - one measure out for every four measures in height.
- Ladders should be placed on a firm level surface.
- The top should rest on something solid.

## Electrical power tools

- Always use RCD's (Residual Current Devices) when using power tools outdoors.
- Never use in wet conditions.
- Follow the safety instructions provided with the tools.

# Overhead Irrigation Installation Guide

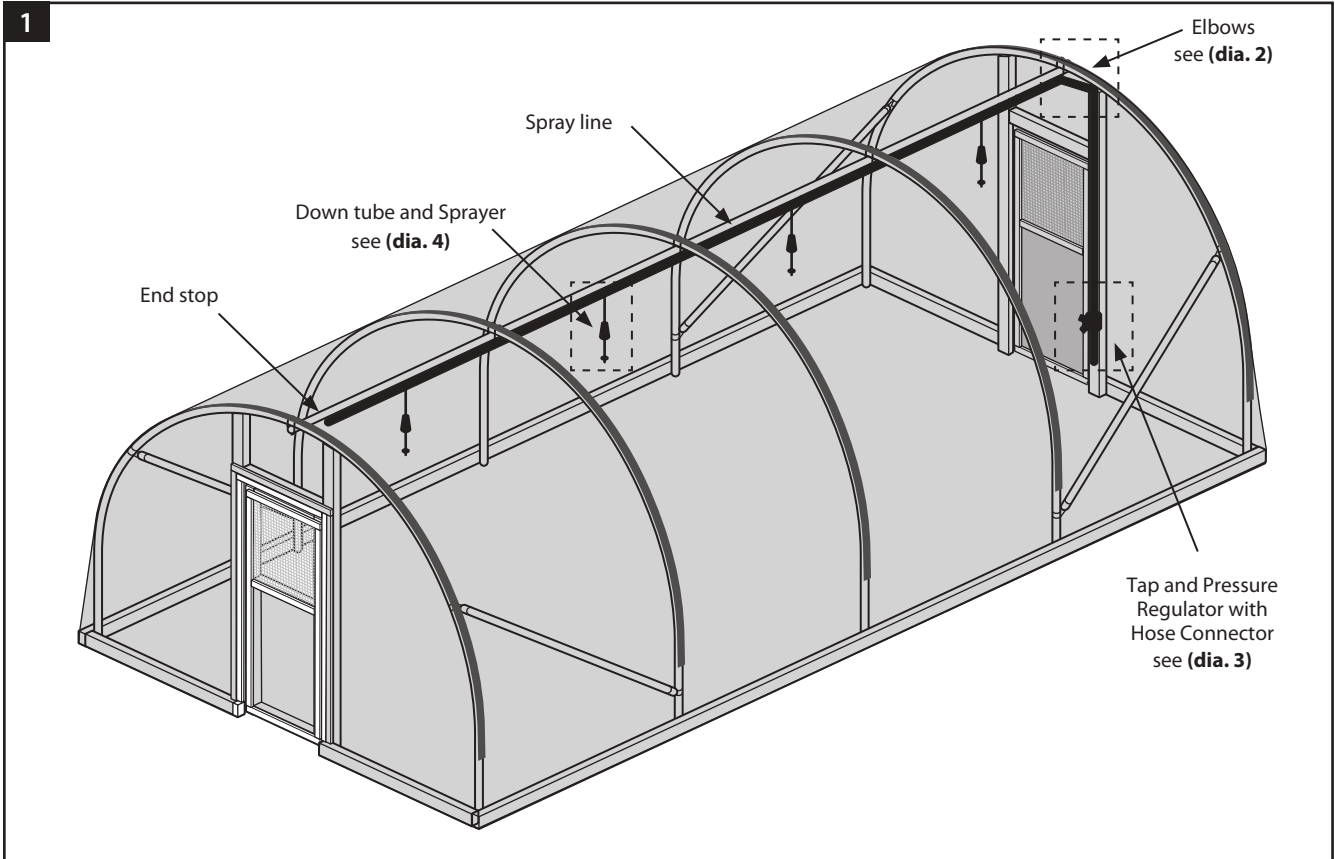

**TOOLS REQUIRED.** Hacksaw, Sharp knife, Hammer and a Phillips Screwdriver.

## Overhead Irrigation

The system you have purchased consists of a 20mm spray line which attaches to the ridge of the Polytunnel and continues down the door post where it connects to a hose-pipe. The water inlet system pipe contains a ball valve (tap), pressure regulator and hose connector (**dia.1**).

## Overhead Spray-line

Using a sharp knife, cut a section of 20mm pipe 1m shorter than the length of your Polytunnel to form the spray line. At one end of the pipe push in the barbed end stop and at the opposite end fit a barbed elbow. These barbed fittings are a tight fit and may require some force to fully press home (**dia.2**).

Fix the pipe to the ridge using the cable ties spaced equally down the polytunnel length. Ensure that the pipe with the fitted elbow is at the end where the water supply will enter the Polytunnel. The pipe may bend and weave to avoid fixtures and fittings but this is allowed. (Leave the ties slightly loose at this stage to allow the pipe to move).

### TIP

Inserting the barb fittings into the pipe can be very tight - holding the pipe in hot water for a few seconds will help.

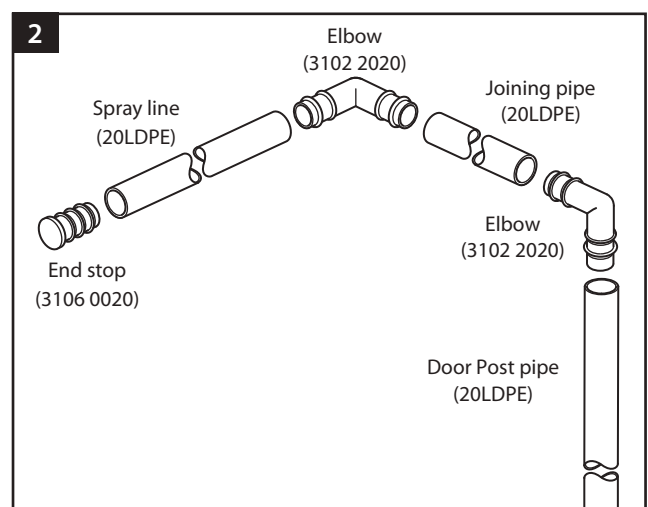

### TIP

Flush out and drain water irrigation tubes so they don't crack in frosty weather

# Overhead Irrigation Installation Guide

## Door Post Pipe System

Turn the elbow in the overhead spray line so that it is pointing in the direction of the door post you have chosen to support the pipe work. Cut a short piece of the remaining 20mm pipe at a length that spans the distance between the elbow in the spray line and the centre of the doorpost. Push a barbed elbow into one end of this joining pipe and push the opposite end of the pipe onto the barbed elbow on the spray line (**dia.2**).

Assemble the Water Inlet System using the remainder of the 20mm pipe and the parts shown (**dia.3**). Use 2-3 complete turns in a clockwise direction of PTFE tape to join the Tap to the Pressure Regulator, see (**dia.3 detail**). Hold this assembly up to the door post and decide on a suitable height for the tap. Cut the Water Inlet System pipe to match up to the elbow in the joining pipe. (Ensure that the joining pipe is as close to the horizontal as possible). Using the pipe clamp screw this to the door post in line with the joint between the tap and pressure regulator whilst holding the tap at the required height. Clip the pressure regulator into the pipe clamp to prevent the manifold from sliding up and down. Use the nail on pipe clamps to fix the remainder of the Water Inlet System pipe to the door post.

## Spray Nozzles

Tighten the cable ties along the ridge and use the hole punch to punch a hole approximately in the middle of a hoop space in the underside see (**dia. 4 detail**). Insert a down tube adaptor in each hole using the punch for assistance. Assemble the down tube and spray nozzle (**dia.4**) and insert into each of the adaptors. Note the direction of flow on the Anti drip valve.

### TIP

The Anti Drip Valve used is designed to prevent the sprayers from dripping when the water supply is turned off. However, low water pressure supplies may not close the valve and so prevent the system from working correctly. If so these valves can be removed to improve the effectiveness of the system.

## Prestige Overhead Irrigation (if ordered).

If you ordered a Prestige Irrigation System then you will need to fit the Water Controller onto the tap of your water source. The water controller is supplied with fittings for either a 3/4in or 1in male threaded tap. Use the two 'Hose to Female Click' fittings to run a hose between the 'Male Click' fittings on the Water Controller and the Polytunnel. You will require a hose pipe and may require extra 'Click' fittings depending on the type of tap being used.

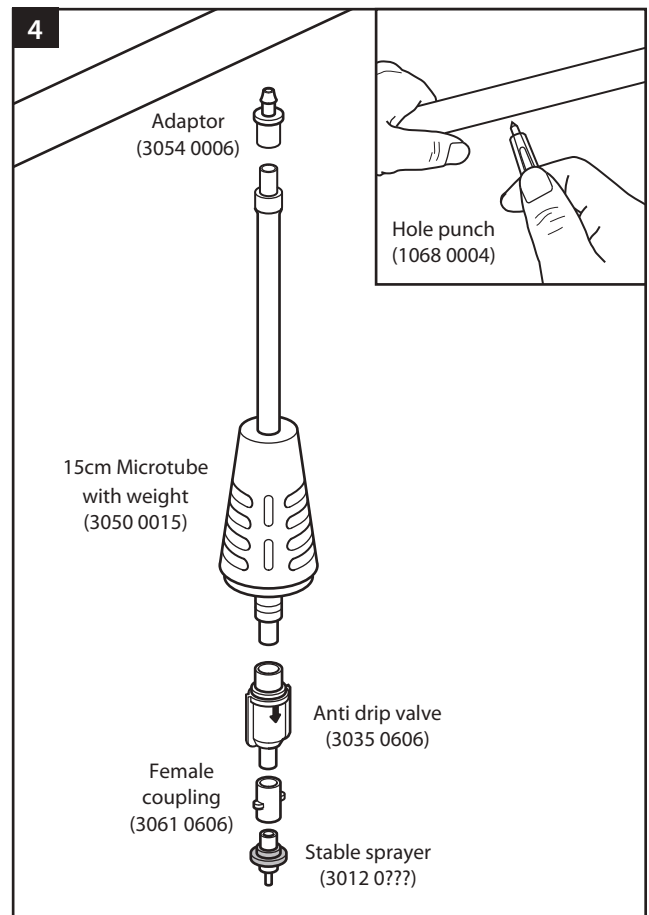
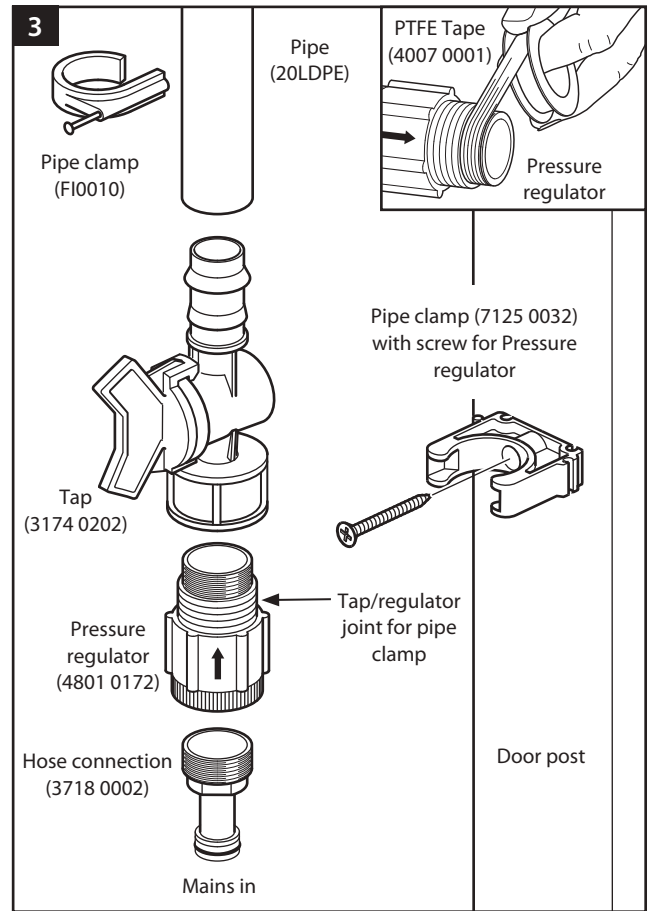

# PARTS

Quantities depend on the length of your Polytunnel

## PFRK

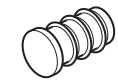

Male plug  
(3106 0020)

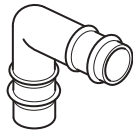

Elbow  
(3102 2020)



Hose  
connection  
(3718 0002)

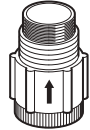

Pressure  
Regulator  
(4801 0172)

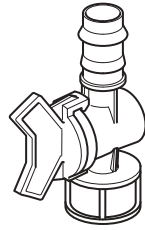

Tap  
(3174 0202)



Pipe Clamp  
(FI0010)

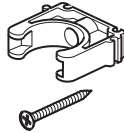

Clamp and Screw  
(7125 0032)



PTFE tape  
(4007 0001)

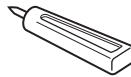

Hole punch  
(3068 0003)

### Pipe Fixing and Regulator Kit

## DTA

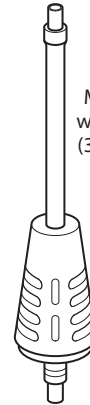

15cm  
Microtube  
with weight  
(3050 0015)



Adaptor  
(3054 0006)



Anti drip  
valve  
(3035 0606)



Female  
coupling  
(3061 0606)



Stable  
sprayer  
(3012 0???)

### Down Tube Assembly

## 20LDPE

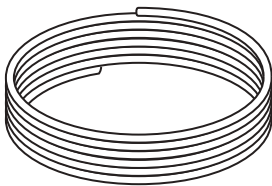

LDPE 20mm Pipe (6bar)

## FI0008

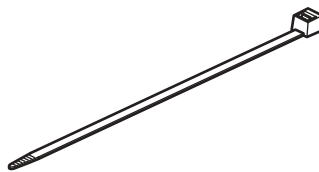

27cm Cable Ties

## WC0001, 3711 0001

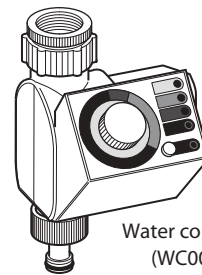

Water controller  
(WC0001)

Hose connection  
(3711 0001)

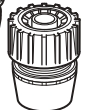
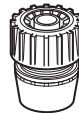

### Controller and Connectors







# FIRST TUNNELS

*the growing season just got longer*

If you experience any difficulties during construction please call us on:

**Monday to Friday (9am - 5pm) 01282 601253**  
**Saturday & Sunday (9am - 5pm) 07801 601253**  
**Email/Web: [help@firsttunnels.co.uk](mailto:help@firsttunnels.co.uk) or visit our web site [www.polytunnels.co.uk](http://www.polytunnels.co.uk) for assistance.**



We know many people build their polytunnels at the weekend when our office is closed.

So we've set up the First Tunnels Construction Helpline specifically for these weekend periods. This allows you to talk directly to a constructor, ask their expert opinion, get the answers and complete your polytunnel.

If you'd like us to ring you, simply send us a text and we'll ring you back. If you are an O2 customer the call will be free of charge. Please note this service is NOT available over the Christmas period and Bank Holidays.

Share your gardening pictures and videos, post hints, tips and experiences.  
PLUS... find out more about our online gardening community.



[www.PolytunnelGardening.co.uk](http://www.PolytunnelGardening.co.uk)



[www.facebook.com/polytunnels](http://www.facebook.com/polytunnels)



[www.youtube.com/polytunnels](http://www.youtube.com/polytunnels)

**Copyright © First Tunnels Ltd 2012.**

All rights reserved. No part of this document may be reproduced or transmitted in any form, by any means (electronic, photocopying, storing in any medium, recording, or otherwise) without the prior written permission of First Tunnels Ltd.